

Portagetto a cavallotto
Clamp type nozzle holder

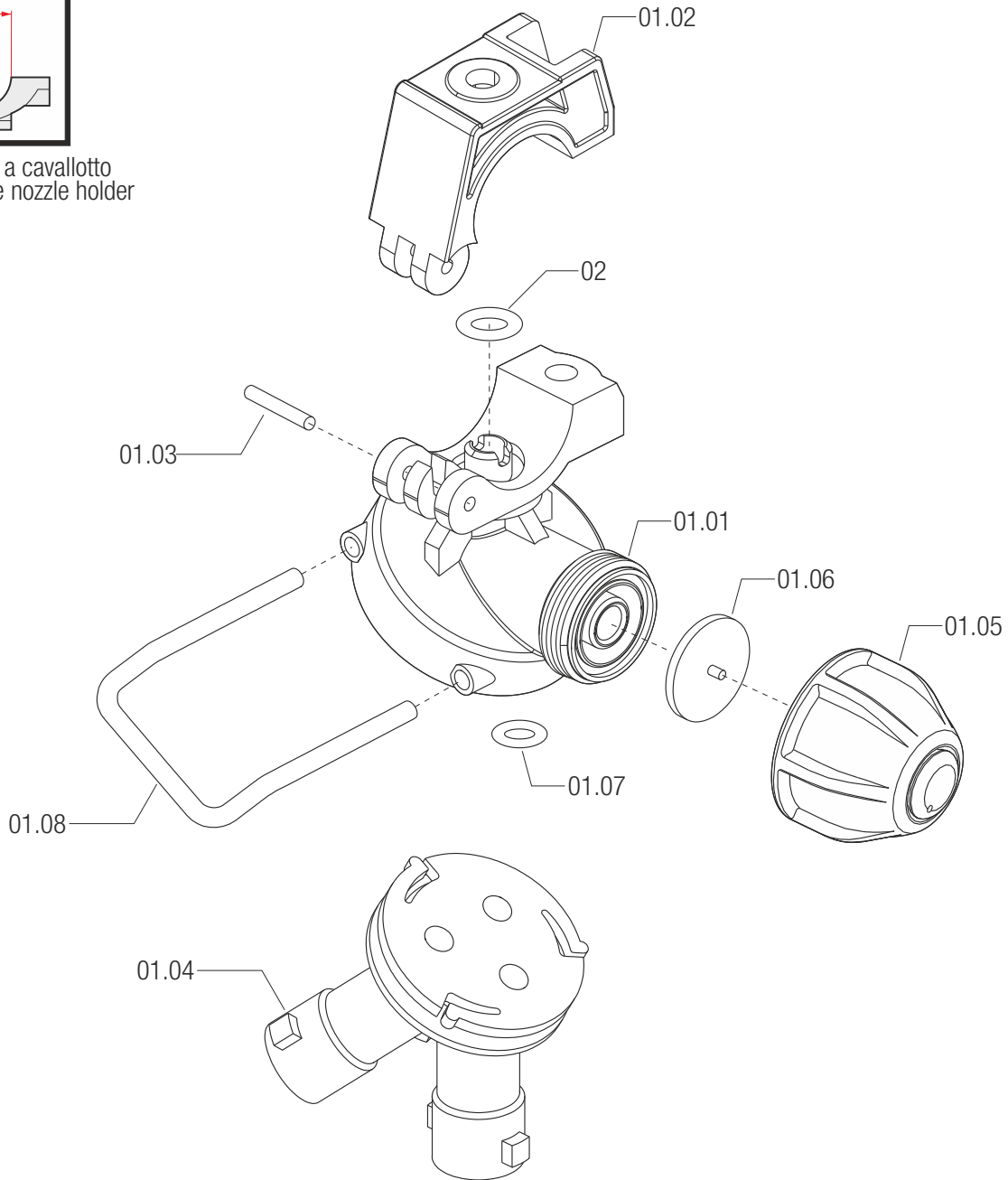

RIFERIMENTO	CODICE	DESCRIZIONE	RIFERIMENTO	CODICE	DESCRIZIONE
01.01	4012747.010	CORPO TRIJET C/SN D1/2 F10	01.06	005860.036	MEMBRANA ANTIGOCCIA EPDM
01.02	400535.020	CAVALLOTTO SNODATO D1/2 B/PIANA	01.07	403000.050V	OR 2,40X 7,30 VITON
01.03	400530.040	PERNO PER CAVALLOTTO D.3X22	01.08	401000.080	FERMO A FORCHETTA TRI-GET
01.04	4012200.020	PORTA UGELLI.TRI-GET ATT.AMER. STOP	02	G11057	OR 2,62X 9,13 109 EPDM
01.05	402012.100	CAPS.ANTIG.ROSSA 0,5B C/NERO			