

Portagetto a cavallotto
Clamp type nozzle holder

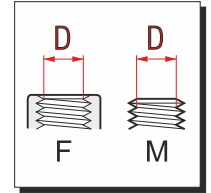

Portagetto filettato
Threaded nozzle holder

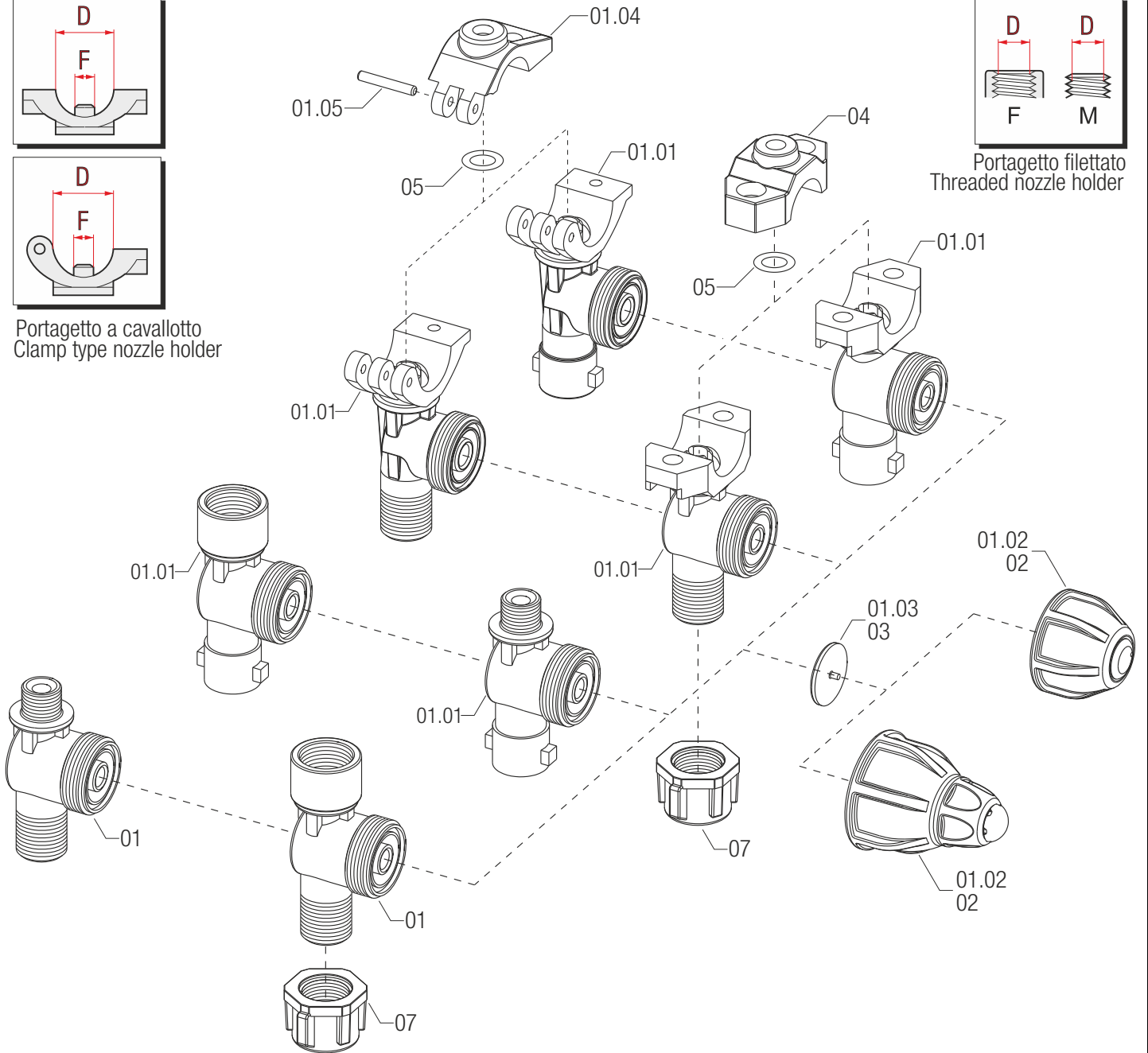

RIFERIMENTO	CODICE	DESCRIZIONE	RIFERIMENTO	CODICE	DESCRIZIONE
01.01	4027151.010	CORPO UNIGET C/SN D19 F10	01.04	400520.020	CAVALLOTTO SNODATO D20
01.02	402012.100	CAPS.ANTIG.ROSSA 0,5B C/NERO	01.05	400530.040	PERNO PER CAVALLOTTO D.3X22
01.03	005860.036	MEMBRANA ANTIGOCCIA EPDM	05	G11057	OR 2,62X 9,13 109 EPDM