

Portagetto a cavalletto
Clamp type nozzle holder

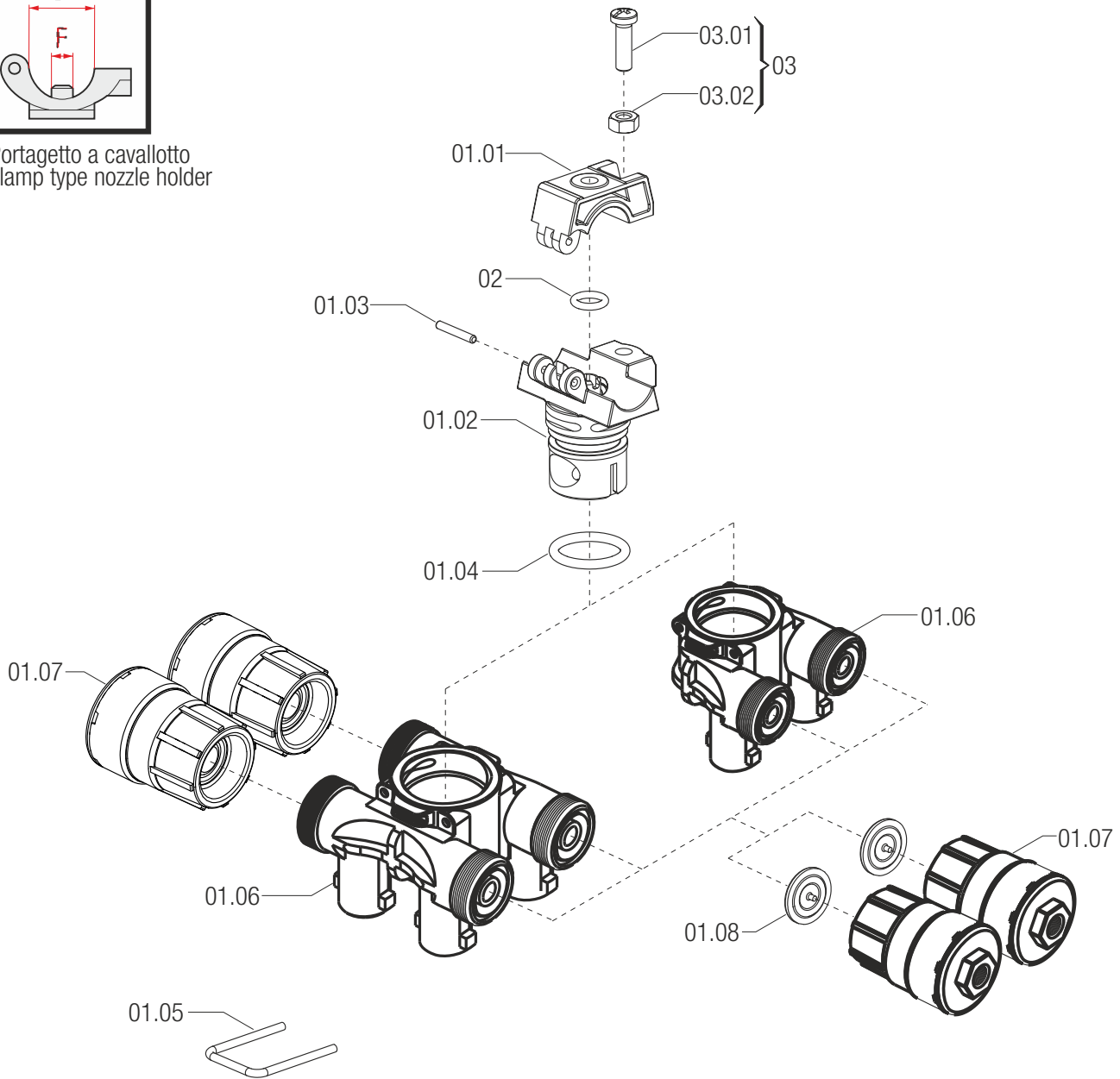

RIFERIMENTO	CODICE	DESCRIZIONE
01.01	400557.020	CAVALLOTTO SNODATO D3/4 B/PIANA
01.02	4063050.010	CORPO UNIGET D3/4 F10
01.03	400530.040	PERNO PER CAVALLOTTO D.3X22
01.04	G11076V	OR 3,53X 23,4 OR4093 VITON
01.05	010003	FORCHETTA FILO D=3 INTER.29

RIFERIMENTO	CODICE	DESCRIZIONE
01.06	4063400.010	CORPO PORTAGETTI PNEUMATICO DOPPIO
01.07	424510.900	FLOW STOP A MEMBRANA PNEUM. PREMON.
01.08	424510.060V	MEMBRANA FLOW STOP VITON
02	G11057	OR 2,62X 9,13 109 EPDM
03	400101	KIT VITE E DADO M6 INOX